

## FITTING INSTRUCTION

Clamp mark in acc. with		Cables joining
ISO	PN	
1	L	Left directional lights
2	+	Rear fog lights
3	31	Ground
4	R	Right directional lights
5	58R	Right side parking lights
6	54	Stoptights
7	58L	Left side parking lights

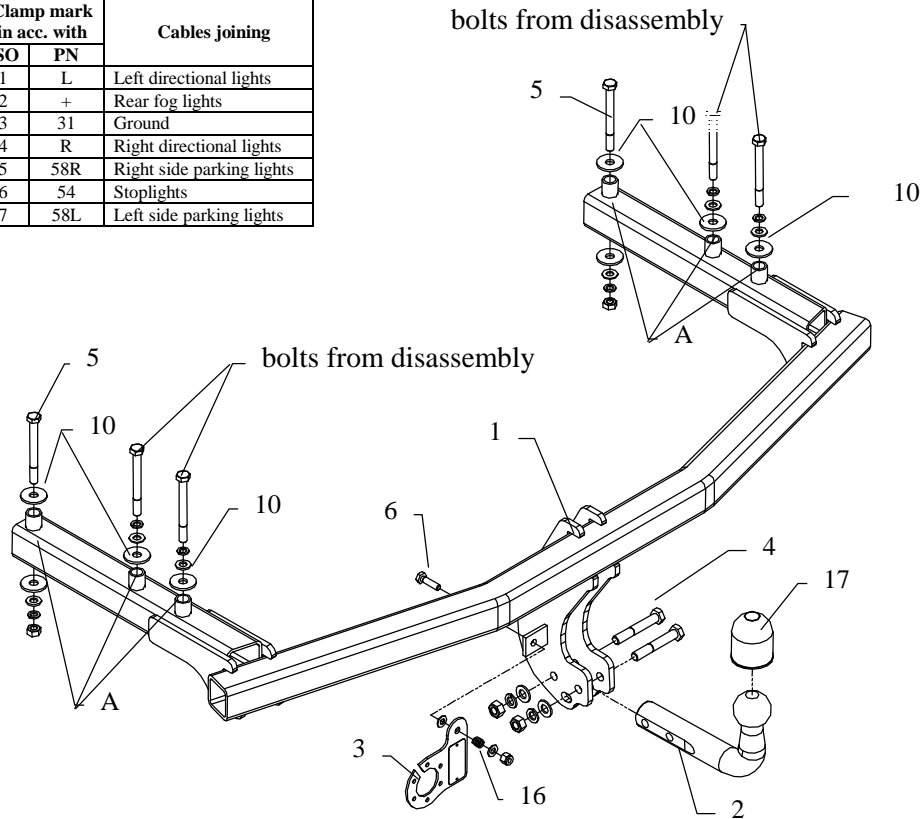

This towbar is designed to assembly in following cars: **AUDI A6 ALLROAD, AVANT, QUATTRO**, produced since 2000 till 2006, catalogue number **A20** and is prepared to tow trailers max total weight **2320 kg** and max vertical load **75 kg**.

Towbar is designed in way excluding disassemble, cut out or drill a bumper.

### *From manufacturer*

Thank you for buying our product. Their reliability has been confirmed in many tests. Reliability of towbar depends also on correct assembly and correct exploitation. For this reasons we kindly ask to read carefully this instruction and apply to hints.

*The towbar should be install in points described by a car producer.*

## The instruction of the assembly

1. Disassemble the rear bumper and metal reinforcement (reinforcement not used any more).
2. To chassis members slip main bar of the towbar (pos. 1) and position with this way, so holes (pos. A) agree with original holes in chassis members and fix it using bolts M10x100mm (pos. 5) and bolts from disassembly, use also big washers  $\varnothing 35 \times \varnothing 12 \times 3$ mm (pos. 10).
3. Reassemble the bumper.
4. Screw tow-ball (pos. 2) using bolts M12x75mm (pos. 4) from accessories.
5. Tighten all bolts according to the torque shown in the table.
6. Connect electric wires of 7-poles socket according to the instruction of the car. (Recommend to make at authorized service station)
7. Complete paint layer damaged during installation.

Torque settings for nuts and bolts (8,8):

<b>M6</b> - 11 Nm	<b>M8</b> - 25 Nm	<b>M10</b> - 50 Nm
<b>M12</b> - 87 Nm	<b>M14</b> - 138 Nm	<b>M16</b> - 210 Nm











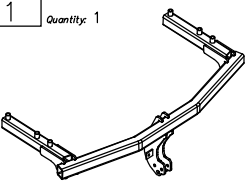
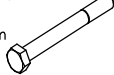

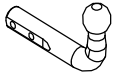

## NOTE

After install the towbar you should get adequate note in registration book (at authorised service station).The car should be equipped with:

- Indicators
- Tow mirrors

After 1000km of exploitation check all bolts and nuts. The ball of towbar must be always kept clear and conserve with a grease.

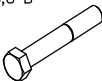
## Towbar accessories:

Pos. 1 Name: Main bar Quantity: 1 	Pos. 5 Name: Bolt 8,8 B Quantity: 2 Dim.: M10x100mm 	Pos. 10 Name: Washer Quantity: 8 Dim.: $\phi 35 \times \phi 12 \times 3 \text{ mm}$ 	Pos. 15 Name: Spring washer Quantity: 6 Dim.: $\phi 10,2 \text{ mm}$ 
	Pos. 6 Name: Bolt 8,8 B Quantity: 1 Dim.: M8x30mm 	Pos. 11 Name: Plain washer Quantity: 2 Dim.: $\phi 13 \text{ mm}$ 	Pos. 16 Name: Spring Quantity: 1 
Pos. 2 Name: Tow ball Quantity: 1 	Pos. 7 Name: Nut 8 B Quantity: 2 Dim.: M12 	Pos. 12 Name: Plain washer Quantity: 6 Dim.: $\phi 10,5 \text{ mm}$ 	Pos. 17 Name: Ball cover Quantity: 1 
Pos. 3 Name: Socket plate Quantity: 1 	Pos. 8 Name: Nut 8 B Quantity: 2 Dim.: M10 	Pos. 13 Name: Plain washer Quantity: 2 Dim.: $\phi 8,5 \text{ mm}$ 	
Pos. 4 Name: Bolt 8,8 B Quantity: 2 Dim.: M12x75mm 	Pos. 9 Name: Nut 8 B Quantity: 1 Dim.: M8 	Pos. 14 Name: Spring washer Quantity: 2 Dim.: $\phi 12,2 \text{ mm}$ 	



**PPUH AUTO-HAK S.J.**

Produkcja Zaczepów Kulowych  
Henryk & Zbigniew Nejman  
76-200 SŁUPSK ul. Słoneczna 16K  
tel/fax (059) 8-414-414; 8-414-413  
E-mail: office@autohak.com.pl  
www. autohak.com.pl

## Towing hitch (without electrical set)

Class: **A50-X** Cat. no. **A20**

Designed for:

Manufacturer: **AUDI**

Model: **A6**

Type: **AllRoad, Avant Quattro**

produced since 2000 till 2006

Technical data:

**D-value: 11,70 kN**

maximum trailer weight: **2320 kg**

maximum vertical cup load: **75 kg**

Approval number acc. to regulations EKG/ONZ 55.01: **E20-55R-01 1826**

## Foreword

This towbar is designed according to rules of safety traffic regulations. The towing hitch is a safety component and can be install only by qualified personnel. Any alteration or conversion of the towing hitch is prohibited and would lead to cancellation of design certification. Remove insulating compound and underseal from vehicle (if present) in the area of the matting surfaces of the towing hitch.

The vehicle manufacturer's specifications regarding trailer load and max. vertical cup load are decisive for driving, and values for the towing hitch cannot be exceeded.

*D-value formula:*

$$\frac{\text{Max trailer weight [kg]} \times \text{Max vehicle weight [kg]}}{\text{Max trailer weight [kg]} + \text{Max vehicle weight [kg]}} \times \frac{9,81}{1000} = D \text{ [kN]}$$